

# A brief study on laser ignition system and its performance requirements

SA Tejas<sup>1\*</sup>, P Dharshak Chandra<sup>2</sup>, P Dattathreya<sup>3</sup>, N Vinith Gowda<sup>4</sup> and S Shivakumar<sup>5</sup>

Department of Mechanical Engineering, Sir M. V. I. T, Bengaluru

## ABSTRACT

### Keywords:

Laser Ignitor,  
Spark Plug,  
Nox Emissions,  
Fuel Efficiency,  
Gas Lasers,  
Multi Point Ignition

Combustion is one of the most prominent energy conversion processes used in all areas of human life, even though it is being used on a large scale in various fields it has vital drawbacks like emission of greenhouse gases from IC engines majorly affecting the environment on a global level. One of the reasons of this issue being improper or inefficient ignition of the air-fuel mixture. However, this can be reduced to an extent by employing methods like lean combustion and re-circulating the exhaust gases. This is when the need of an alternative ignition system is required, one such concept being LASER IGNITION SYSTEM for internal combustion engines. On comparison laser ignition system provides number of potential benefits over conventional ignition by electric spark plug. Use of laser ignition system comes with advantages like- Reduction of NOx emission by 20% also improved efficiencies are obtained. The thermodynamic requirements of high compression ratios and high power density are fulfilled well by this system. Therefore, laser ignitors could replace conventional spark plugs in automobile industry. This not only provides better performance and fuel economy, but would also create less harmful emissions.

## 1. Introduction

Combustion processes of various kinds are widely used in industrial applications. The ignition location and the ignition time play a vital role in the combustion process. Ignition is defined as the initiation of a self-sustained reaction which propagates through the combustible material even after removing the ignition source. Conventional ignition systems like electric spark plugs in IC engines create a spark using high potential difference between the two electrodes by ionizing the air-fuel mixture in the combustion chamber. However, this spark cannot be targeted to a particular location in the chamber thus resulting in incomplete combustion [1]. This leads to disadvantages like- emission of NOx, electrode erosion and carbon layer formation on the electrodes, creating a need for alternate ignition solutions, of which LASER IGNITION SYSTEM can be one of the most promising replacement. It aids complete combustion of the air-fuel mixture leading to reduced emission of harmful gases and increased efficiency of the engine. Lasers are attractive ignition sources as proven by extensive

research in the field of laser ignition performed in the last few decades. In competing with electric spark plug ignition laser ignition offers several advantages, at least theoretically. First, there is no quenching effect of the combustion flame kernel [2]. This is because a laser beam can be transferred to and subsequently focussed into an engine cylinder by a few optical elements (in general these are some lenses and a window) that are placed externally to the cylinder. The internal protruding electrodes of an electrical spark plug are redundant. Another major advantage of laser ignition is the ability to target the laser beam to any benefiting point within the combustion chamber. In this way the flame propagation distance can be optimized and the combustion duration can be reduced. There are four different ways in which laser light can interact with a combustible mixture to initiate an ignition event namely - 1. Thermal initiation, 2. Non resonant breakdown, 3. Resonant breakdown, and 4. Photochemical ignition. Out of the above stated different ways non resonant breakdown is more frequently used because of its freedom in selecting the laser wavelength and ease of implementation. At present the laser ignition plug is very expensive and commercially not yet available.

\*Corresponding author,  
E-mail: 8tejas.sa@gmail.com(Tejas SA)

## 2. Types of Ignition

Ignition is the process of starting radical reactions until a self-sustaining flame has developed. One can distinguish between auto ignition, induced ignition and photo-ignition, the laser being caused by photolytic generation of radicals.

**a. Compression ignition (CI) or auto:** Ignition at certain values of temperature and pressure a mixture will ignite spontaneously, this is known as the auto ignition or compression ignition.

**b. Induced ignition:** A process where a mixture, which would not ignite by it, is ignited locally by an ignition source (i.e. Electric spark plug, pulsed laser and microwave ignition source) is called induced ignition. In induced ignition, energy is deposited, leading to a temperature rise in a small volume of the mixture, where auto ignition takes place or the energy is used for the generation of radicals. In both cases subsequent flame propagation occurs and sets the mixture on fire.

**c. Conventional spark plug ignition:** Conventional spark plug ignition has been used for many years. For ignition of a fuel-air mixture the fuel-air mixture is compressed and at the right moment a high voltage is applied to the electrodes of the spark plug. A spark plug is an electrical device that fits into the cylinder head of some internal combustion engines and ignites compressed air-fuel mixture by means of an electric spark. Spark plugs have an insulated centre electrode which is connected by a heavily insulated wire to an ignition coil assembly on the outside. Internal combustion engines can be divided into spark-ignition engines, which require spark plugs to begin combustion, and compression-ignition engines (diesel engines), which compress the air and then inject diesel fuel into the heated compressed air mixture where it auto-ignites. To ignite the air-fuel mixture, electrical energy is transmitted through the spark plug where electrons jump through the gap between the electrodes of the plug, if the voltage supplied is high enough. This electrical spark ignites the air-fuel mixture in the combustion chamber. The temperature of the firing end must be kept low enough to prevent pre-ignition, but high enough to prevent fouling.

### 2.1. Operation

The plug is connected to the high voltage generated by an ignition coil. As the electrons

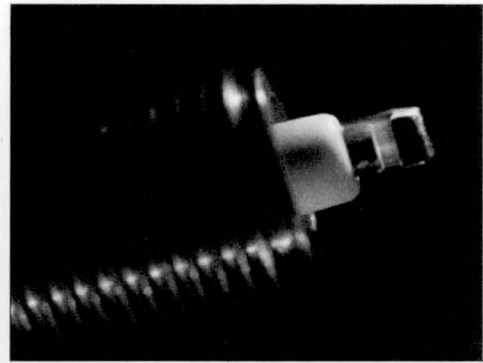

Fig. 1. Conventional electric spark plug.

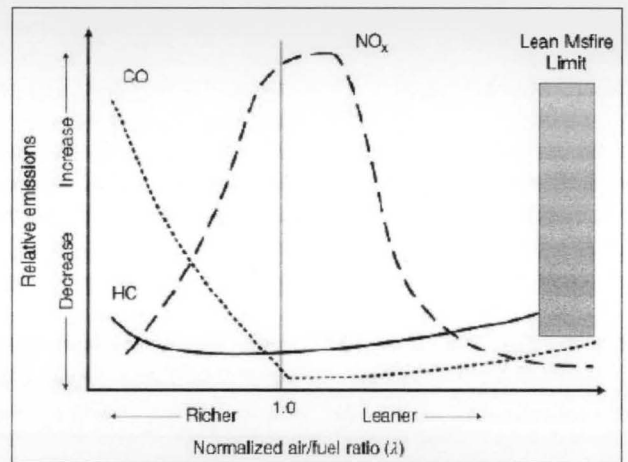

Fig. 2. Graphical representation of emission from engines using an electric spark plug.



Fig. 3. Carbon deposited electric spark plug.

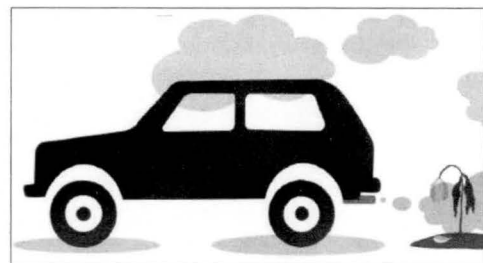

Fig. 4. Sketch representation of toxic gases released due to incomplete combustion.

flow from the coil, a voltage difference develops between the centre electrode and side electrode. No current can flow because the fuel and air in the gap is an insulator, but as the voltage rises further, it begins to change the structure of the gases between the electrodes. Once the voltage exceeds the dielectric strength of the gases, the gases become ionized. The ionized gas becomes a conductor and allow electrons to flow across the gap. Spark plugs usually require voltage in excess of 20,000 volts to 'fire' properly. As the current of electrons surges across the gap, it raises the temperature of the spark channel to 60,000 K. The intense heat in the spark channel causes the ionized gas to expand very quickly, like a small explosion but leaves residual fuel.

### 2.2. Disadvantages of conventional ignition system

Location of spark plug is not flexible as it requires shielding of plug from immense heat and fuel.

- Spray and spark plug location cannot be chosen optimally.
- Spark plug electrodes can disturb the gas flow within the combustion chamber.
- It is not possible to ignite inside the fuel spray.
- It requires frequent maintenance to remove carbon deposits.
- Leaner mixtures cannot be burned, Ratio between fuel and air has to be within the correct range.
- Degradation of electrodes at high pressure and Temperature.
- Flame propagation is slow.
- Multi point fuel ignition is not feasible.
- Higher turbulence levels are required.
- Erosion of spark plug electrodes requires frequent maintenance to remove carbon deposits.

## 3. Laser Ignition System

### 3.1. Laser

A laser is a device that emits electromagnetic radiation through a process of optical amplification based on the stimulated emission of photons. The term "laser" is an acronym for Light Amplification by Stimulated Emission of Radiation. Lasers provide intense and unidirectional beam

of light. Laser are mono chromatic. A laser is created when the electrons in atoms in special glasses, crystals, or gases absorb energy from an electrical current or another laser and become "excited" [3]. The excited electrons move from a lower-energy orbit to a higher-energy orbit around the atom's nucleus. When they return to their normal or "ground" state, the electrons emit photons (particles of light).

### 3.2. Types of laser

There are different types of laser which can be used

- Ruby laser
- Chemical lasers
- Excimer lasers
- Solid-state lasers
- Semiconductor lasers
- Dye lasers

### 3.3. Types of laser ignition system

- Thermal initiation

In thermal initiation of ignition, there is no electrical breakdown of the gas and a laser beam is used to raise the kinetic energy of target molecules in translational, rotational, or vibrational forms. Consequently, molecular bonds are broken and chemical reaction occur leading to ignition with typically long ignition delay times. This method is suitable for fuel/oxidizer mixtures with strong absorption at the laser wavelength. However, if in a gaseous or liquid mixtures is an objective, thermal ignition is unlikely a preferred choice due to energy absorption along the laser propagation direction. Conversely, this is an ideal method for homogeneous or distributed ignition of combustible gases or liquids. Thermal ignition method has been used successfully for solid fuels due to their absorption ability at infrared wavelengths.

- Non-resonant breakdown

In non-resonant breakdown ignition method, because typically the light photon energy is invisible or UV range of spectrum, multiphoton processes are required for molecular ionization. This is due to the lower photon energy in this range of wavelengths in comparison to the molecular ionization energy. The electrons thus freed will absorb more energy to boost their kinetic energy (KE), facilitating further molecular

ionization through collision with other molecules. This process shortly leads to an electron avalanche and ends with gas breakdown and ignition. By far, the most commonly used technique is the non-resonant initiation of ignition primarily because of the freedom in selection of the laser wavelength and ease of implementation.

- **Resonant breakdown**

The resonant breakdown laser ignition process involves, first, a non-resonant multiphoton dissociation of molecules resulting to freed atoms, followed by a resonant photo ionization of these atoms. This process generates sufficient electrons needed for gas breakdown. Theoretically, less input energy is required due to the resonant nature of this method.

- **Photochemical mechanisms**

In photochemical ignition approach, very little direct heating takes place and the laser beam brings about molecular dissociation leading to formation of radicals (i.e., highly reactive chemical species), if the production rate of the radicals produced by this approach is higher than the recombination rate (i.e., neutralizing the radicals), then the number of these highly active species will reach a threshold value, leading to an ignition event. This (radical) number augmentation scenario is named as chain-branching in chemical terms [4].

### 3.4. Working

To provide appropriate ignition timing for combustion, igniter is in communication with an electronic control module (ECM) via a power supply and fibre optics. Based on various input received by ECM like engine speed, engine load, emissions production or output, engine temperature, engine fueling, and boost pressure, ECM may selectively direct a high-energy light beam from a laser energy generator to each igniter via fibre optics cable. ECM include components like memory, a secondary storage device, and a CPU. A battery of 12v to 24v gives power to either ECM or Laser generator or both. The ECM controls the laser energy generator to direct one or multiple laser beams into the combustion chamber. In the laser igniter multiphoton ionization of few gas molecules takes place which releases electrons that readily absorb more photons via the inverse bremsstrahlung process to increase their kinetic energy.

Electrons liberated by this means collide with other molecules and ionize them, leading to an electron avalanche, and breakdown of the gas. Multiphoton absorption processes are usually essential for the initial stage of breakdown because the available photon energy at visible and near IR wavelengths is much smaller than the ionization energy. For very short pulse duration (few picoseconds) the multiphoton processes alone must provide breakdown, since there is insufficient time for electron-molecule collision to occur. Thus this avalanche of electrons and resultant ions collide with each other producing immense heat hence creating plasma which is sufficiently strong to ignite the fuel. The wavelength of laser depends upon the absorption properties of the laser and the minimum energy required depends upon the number of photons required for producing the electron avalanche [5].

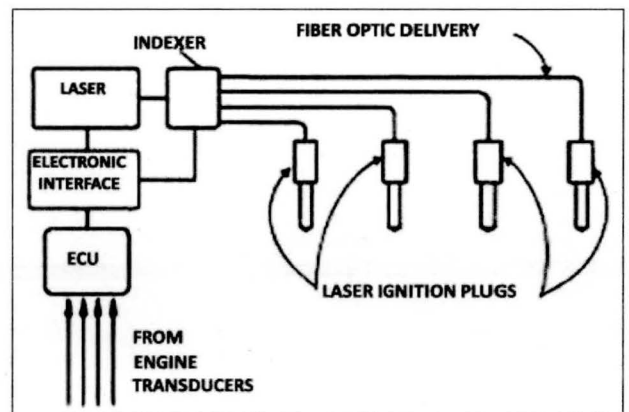

Fig. 5. Working of laser ignition system.

### 3.5. Performance requirements for laser igniters

There are certain performance requirements which a practical laser spark plug should possess, are listed below

- Mechanical: Laser and mounting must be hardened against shock and vibration.
- Environmental: Laser should perform over a large temperature range.
- Peak Power: Laser should provide megawatts raw beam output.
- Average Power: 1-laser per cylinder requires 10Hz for 1200rpm engine operation.
- Life Time: 150 million shots – good, 600 million shots – better [6].

### 3.6. Advantages of using laser ignition system over electric spark ignition

- The lifetime of laser ignitor is much more as compared to the conventional ignition system.
- Laser ignition system can burn leaner mixture more efficiently.
- Precise timing is possible in laser ignition system.
- Reduced fuel consumption rate.
- Free choice of the ignition location within the combustion chamber.
- As laser ignition system can ignite leaner mixture more effectively it will reduce the NOx emissions to a great level.
- Lasers can be focused and split into multiple beams to give multiple ignition points, which means it can give a far better chance of ignition [7].
- Optical wire and laser setup is much smaller than the current spark plug model, allowing for different design opportunities.
- Easier possibility of multipoint ignition.
- Quenching effects of spark plug electrodes are avoided.
- Erosion effects are avoided in laser ignition system.
- The laser also produces more stable combustion so you need to put less fuel into the cylinder, therefore increasing efficiency [8].
- The power required by laser ignition system is less as compared to conventional ignition system.
- Flame propagation is relatively fast combustion time is shorter.

### 3.7. Current research

The Japanese researcher, Taira and his team have created a small, robust and efficient laser that can do the job. They did so by heating ceramic powders, fusing them into optically-transparent solids, then embedding them with metal ions in order to tune their properties. Lasers promise less pollution and greater fuel efficiency, but making small, powerful lasers has, until now, proven hard. To ignite combustion, a laser must focus light to approximately 100 gigawatts per square centimetre with short pulses of more than 10 milli-joules each. Taira's research team overcame this problem by making composite lasers from ceramic powders. The team heats the powders to fuse them into optically transparent

solids and embeds metal ions in them to tune their properties. The composite generates two laser beams that can ignite fuel in two separate locations at the same time. This would produce a flame wall that grows faster and more uniformly than one lit by a single laser. The laser is not strong

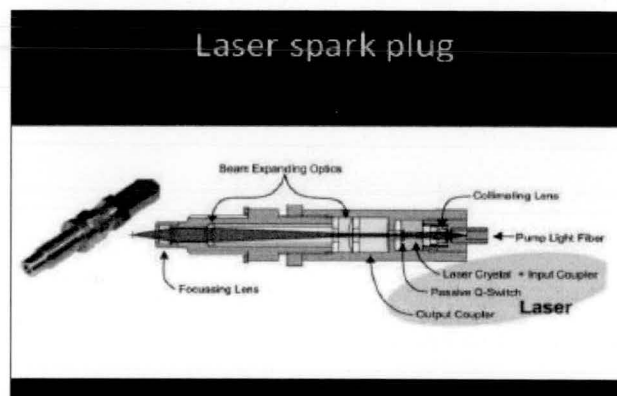

Fig. 6. Laser spark plug.

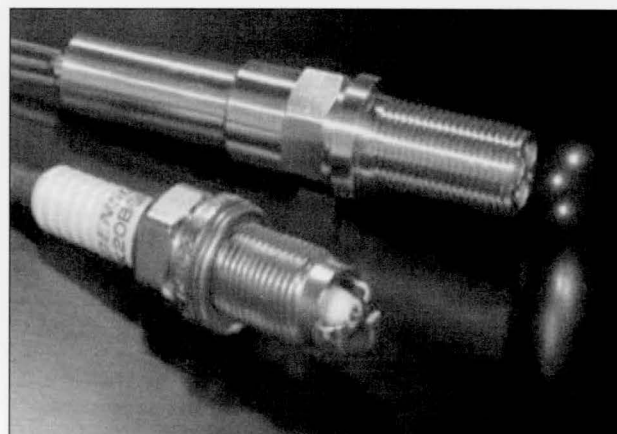

Fig. 7. Electric spark plug & multi-beam laser ignition plug.

- Unlike conventional spark ignition, high pressure requires lower energy for breakdown
- Reduction in exhausts by 20% mainly NO<sub>x</sub>

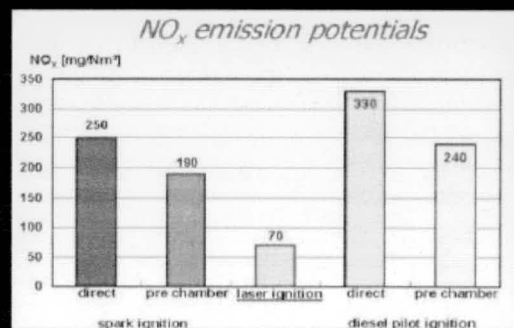

Fig. 8. Bar graph representing NO<sub>x</sub> emission potentials of different ignition systems.

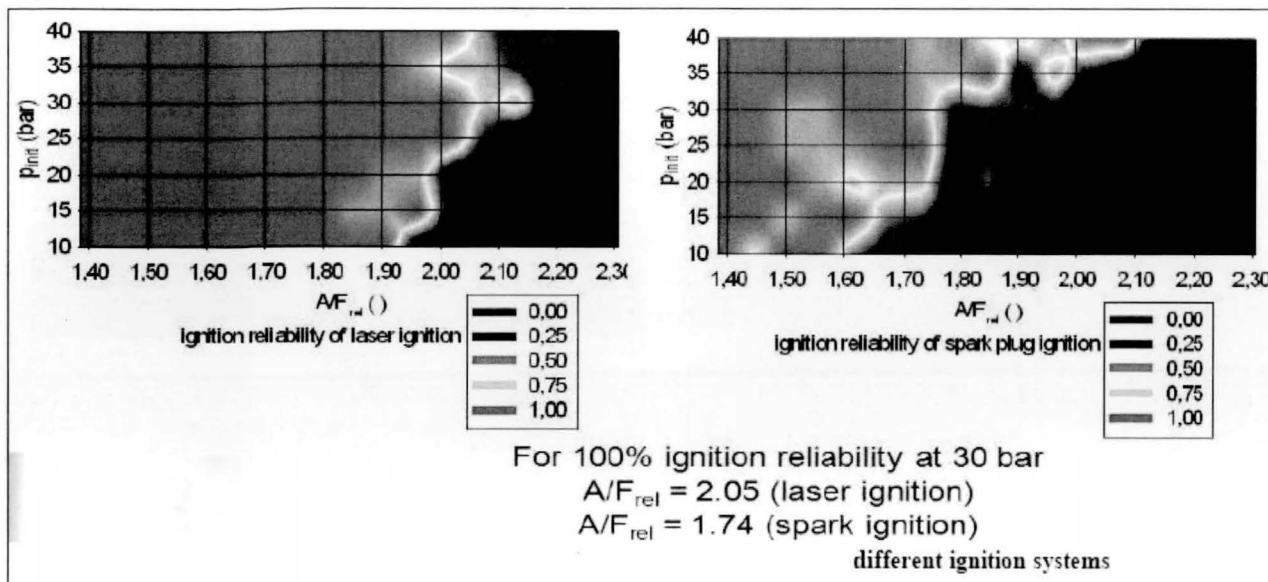

Fig. 9.

enough to light the leanest fuel mixtures with a single pulse. By using several 800-picosecond-long pulses, however, they can inject enough energy to ignite the mixture completely. The laser-ignition system, although highly promising, is not yet being installed into actual automobiles made in a factory. Taira's team is, however, working with a large spark-plug company and with DENSO Corporation, a member of the Toyota Group [9].

#### 4. Conclusion

Based on the above reviewed papers and study, we come to the conclusion that a LASER Ignition Plug can efficiently replace the conventional electric spark plugs in IC Engines. Though several studies and researches have proven laser ignition to be efficient and eco-friendly, this concept is on the prototype stage and is not yet available commercially due to a few constraints one of which is high initial cost. Attempts are being made to bring this concept into real-time usage, hence we hope seeing it being used in vehicles in the near future.

#### References

1. Bradley, D; Sheppard, CGW; Suardjaja, IM; Woolley, R: Fundamentals of high-energy spark ignition with lasers, 'Combust. Flame', vol. 138, no. 1-2, 2004, 55-77.
2. Maker, PD; Terhune, RW; Savage, CM: Optical

third harmonic generation, In: '3<sup>rd</sup> Int. Conf. Quantum Elect., Paris, France', 1963, 1559-1572.

3. Dodd, RD: Laser Ignition of an Internal Combustion Engine, PhD Thesis, Univ. of Liverpool, 2007.
4. Dale, J D; Smy, PR; Clements, RM: Laser ignited internal combustion engine – An experimental study, 'Proceedings of SAE Congress Detroit', paper 780329.
5. Phuoc, TX: Laser-induced spark ignition fundamental and applications, 'Optics and Lasers in Eng', vol. 44, 351-397, 2006.
6. Mullett, JD: Laser-Induced Ignition Systems for Gasoline Automotive Engines, PhD Thesis, University of Liverpool, 2009.
7. Ronney, PD: Laser versus conventional ignition offlames, 'Opt. Eng.', vol. 33, no. 2, 1994.
8. Kofler, H: Development of a Laser Spark Plug and Comparative Testing, PhD Thesis, Faculty of Electrical Engineering and Information Technology, Vienna University of Technology, Vienna, Austria, 2009.
9. Gupta, S; Sekar, R; Fiskum, R: In-cylinder NO<sub>x</sub> Reduction Technologies in Advanced Reciprocating Engine Systems (ARES), ARES Peer Review, Arlington, VA, Dec. 13-15, 2005 ■



**S Shivakumar**, Assistant Professor, Dept. of Mechanical Engineering, Sir M Visvesvaraya Institute of Technology, Bengaluru. He graduated in 2001 and obtained his post graduation in 2006, He is persuing his research under the guidance of Dr. G. Balakumar. He has 15 years of teaching experience and published 6 National papers & 2 International papers. His area of interest includes design engineering, mechanics of materials, design of machine elements, control engineering, hydraulics and pneumatics, computer aided engineering drawing, theory of elasticity, theory of plasticity kinematics of machines, robotics, elements of mechanical engineering.  
(E-mail: hkumar.hiremath@gmail.com)

**Tejas SA** is currently undergoing his UG program in Industrial Engineering and Management at Sir M. Visvesvaraya Institute of Technology, Bengaluru affiliated to VTU, Belagavi. Being a leader from his school time his areas of major interests have developed in fields related to management and leadership, which include Inventory management, process planning and entrepreneurship. (E-mail: 8tejas.sa@gmail.com)

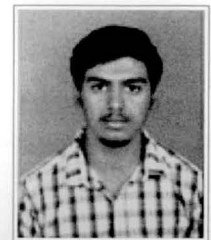

**Dharshak Chandra P** is currently undergoing his UG program in Industrial Engineering and Management at Sir M. Visvesvaraya Institute of Technology, Bengaluru affiliated to VTU, Belagavi. His areas of interests are manufacturing process, automation, product management and quality control.  
(E-mail: dharshakchandra@gmail.com)

**Dattathreya P** is currently undergoing his UG program in Industrial Engineering and Management at Sir M. Visvesvaraya Institute of Technology, Bengaluru affiliated to VTU, Belagavi. His major areas of interests are quality control and supply chain management. (E-mail: dattathreya2310@gmail.com)



**Vinith Gowda N** is currently undergoing his UG program in Industrial Engineering and Management at Sir M. Visvesvaraya Institute of Technology, Bengaluru affiliated to VTU, Belagavi. His major fields of interests are designing, robotics and automation. (E-mail: vinithgowda4100@gmail.com)